

LAYOUT PLAN

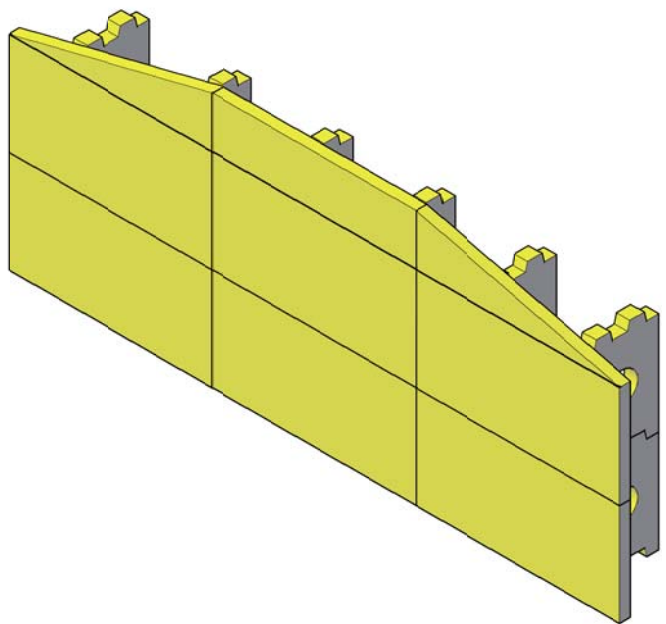

FRONT ISOMETRIC VIEW

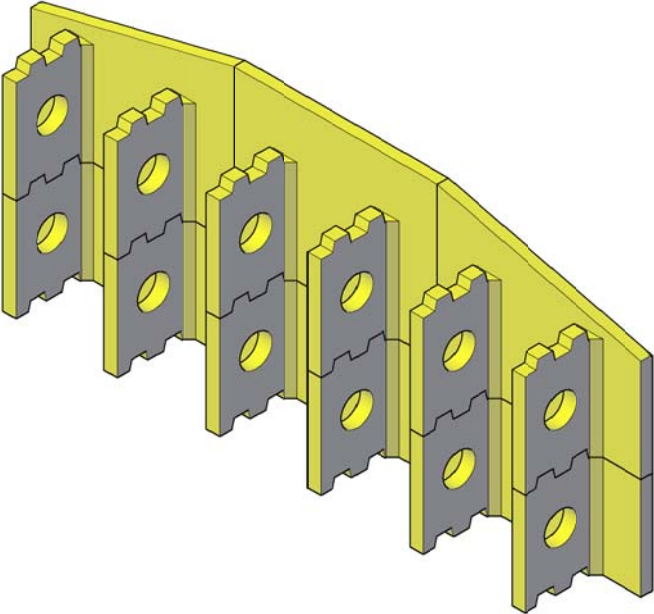

REAR ISOMETRIC VIEW

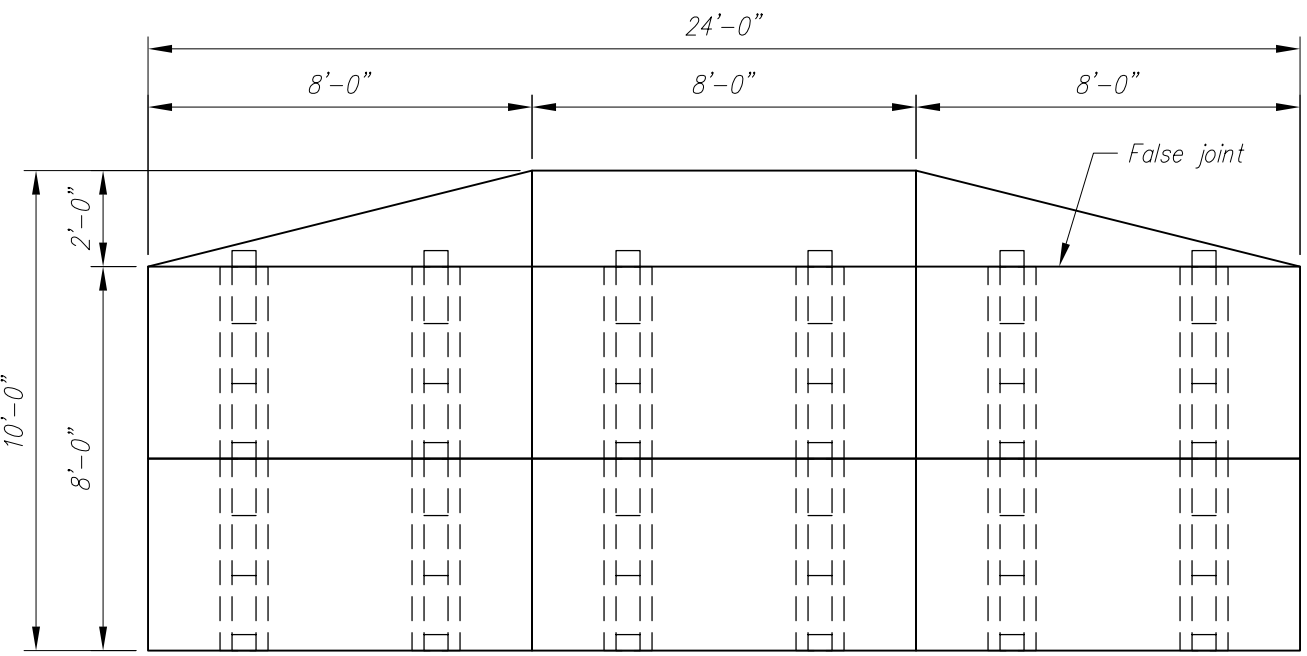

LAYOUT FRONT ELEVATION

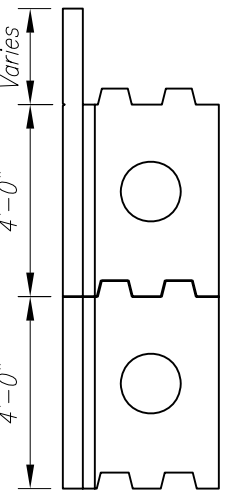

LAYOUT SIDE ELEVATION

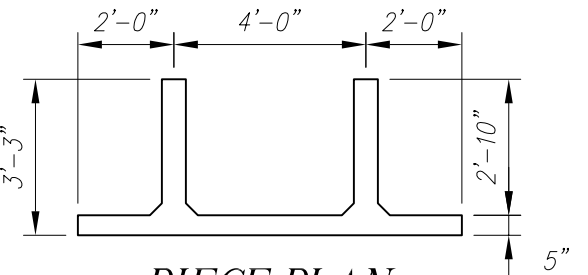

PIECE PLAN

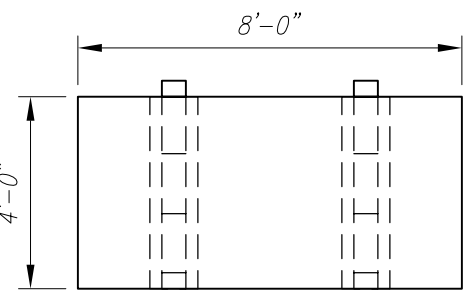

PIECE FRONT ELEVATION

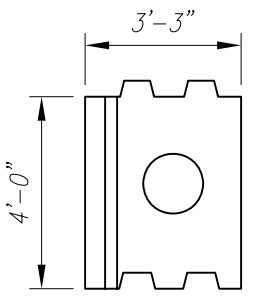

PIECE SIDE ELEVATION

| | | | |
|-----------|------|-------------|----|
| 5 | | | |
| 4 | | | |
| 3 | | | |
| 2 | | | |
| 1 | | | |
| Rev. | Date | DESCRIPTION | By |
| REVISIONS | | | |

Concrete Systems Inc.
 9 Commercial St., Hudson, NH, 03051
 Phone 603-889-4163
 Fax 603-889-2417

| | | | |
|------------------|----------------|--------------|-----|
| STATE AGENCY | | | |
| Drawn By | Date | B | REV |
| Concrete Cu. Yd. | Weight in Tons | | 0 |
| Approved By | Date | Drawing No. | |
| Quantity: 1 | Project No: | SHEET 1 OF 1 | |